

# THE NEW X1



This PDF contains  
interactive elements



# ALL BMW MODELS IN ONE APP.



DOWNLOAD THE **BMW Products** APP NOW AND  
DISCOVER THE PLEASURE OF DRIVING.



HIGHLIGHTS  
JOURNEY

MODELS

EQUIPMENT

TECHNICAL VALUES  
AND SERVICES



#### Highlights

- Exterior design
- Interior design
- Driving dynamics
- Connectivity
- Charging solutions
- iX1 xDrive 30
- X1 xDrive 23i
- X1 xDrive 30e

#### Vehicle types

##### Models and packages

- BMW electric vehicle
- Base
- M Sport package
- BMW plug-in hybrid
- xLine

#### Equipment

- Equipment highlights
- Wheels and tyres
- Exterior colour world
- Interior colour world
- Genuine BMW Accessories

#### Technical values

##### BMW Services

 [Table of contents is interactive](#)

#### BMW X1 xDrive23i:

20" M light alloy wheels Multi-spoke style 869, exterior colour in Utah Orange Metallic, Verasca Oyster leather, Black high-gloss interior trim.  
Fuel consumption in l/100 km (combined): 7.2–6.5  
CO<sub>2</sub> emissions in g/km (combined): 162–146

#### BMW iX1 xDrive30:

20" M light alloy wheels Multi-spoke style 869, exterior colour in Mineral White metallic, upholstery in Sensatec Mokka, open-pored, fine-wood Eucalyptus interior trim.  
Power consumption in kWh/100 km (combined): 18.4–17.3  
Electric range: 413–438

#### BMW X1 xDrive30e:

20" M light alloy wheels Multi-spoke style 869, exterior colour in Frozen Pure Grey Metallic, upholstery in Alcantara/Sensatec combination in Black/contrast stitching in Blue, Aluminium Hexacube Dark interior trim.  
Power consumption in kWh/100 km (combined): 18.2–16.4  
Electric range: 78–89

The models illustrated in this medium show the equipment and configuration options (standard and optional) for vehicles produced by BMW AG for the German market. Alterations in standard and optional equipment and the configurations available for the different models, as described in this brochure, may occur after 05/02/2022, the date when this brochure went to press. Your local BMW Partner is available to provide further details. Subject to change in design and equipment.

THE BRAVE.



TRUE COURAGE CANNOT BE STOPPED.  
IT DEVELOPS. YOU HAVE THE  
RIGHT TO BE UNIQUE. SPONTANEOUS AND  
FREE. COURAGEOUS AND DETERMINED.  
FOR ONE GOOD REASON:  
BECAUSE THAT'S WHO YOU ARE.



THE COURAGE  
TO BE DIFFERENT.

THE BRAVE – AS PIONEERING AS IT IS  
INDEPENDENT. THE BMW X1 ACCOMPANIES  
YOU CONFIDENTLY THROUGH EVERYDAY  
LIFE AND ALLOWS YOU TO ACHIEVE  
GOALS YOU NEVER THOUGHT POSSIBLE.  
THE FREEDOM TO RELY ON THE RIGHT  
DRIVE SYSTEM. HOP IN AND GET  
INSPIRED – BECAUSE COURAGE COMES  
WITH EXPERIENCE.



Strong proportions and characterful lines define the exterior of the new BMW iX1. The clearly upright front section makes a strong statement of a powerful presence. Harmoniously integrated, the large, almost square kidney in combination with the re-designed, L-shaped front lights shows the striking BMW face in its most modern form.

POWER AND  
ELEGANCE,  
SKILFULLY  
COMBINED.



The long roof line stretches the silhouette in the side view. Generously modelled surfaces convey strength and solidity. The wide, almost square wheel housings emphasise the bold stance of the new BMW iX1. Cladding elements visually lift the vehicle and underline the X-typical robustness.

The flat rear window and the drawn-in window graphic form a striking shoulder area and make the BMW iX1 appear even wider when seen from the rear. Its newly designed, three-dimensional L-shaped rear lights create a lasting impression.



WITH ALL  
FOUR WHEELS  
IN LIFE.

# MORE SPACE FOR PURE DRIVING PLEASURE.



In the interior, a large and open feeling of space meets modern design and innovative functionality. The frameless BMW Curved Display and the elegant decorative elements are consistently geared towards the driver. Design details such as the wide chrome barrette trims, which cover the entire display cluster, emphasise the typically solid BMW X character.

INTERIOR DESIGN.

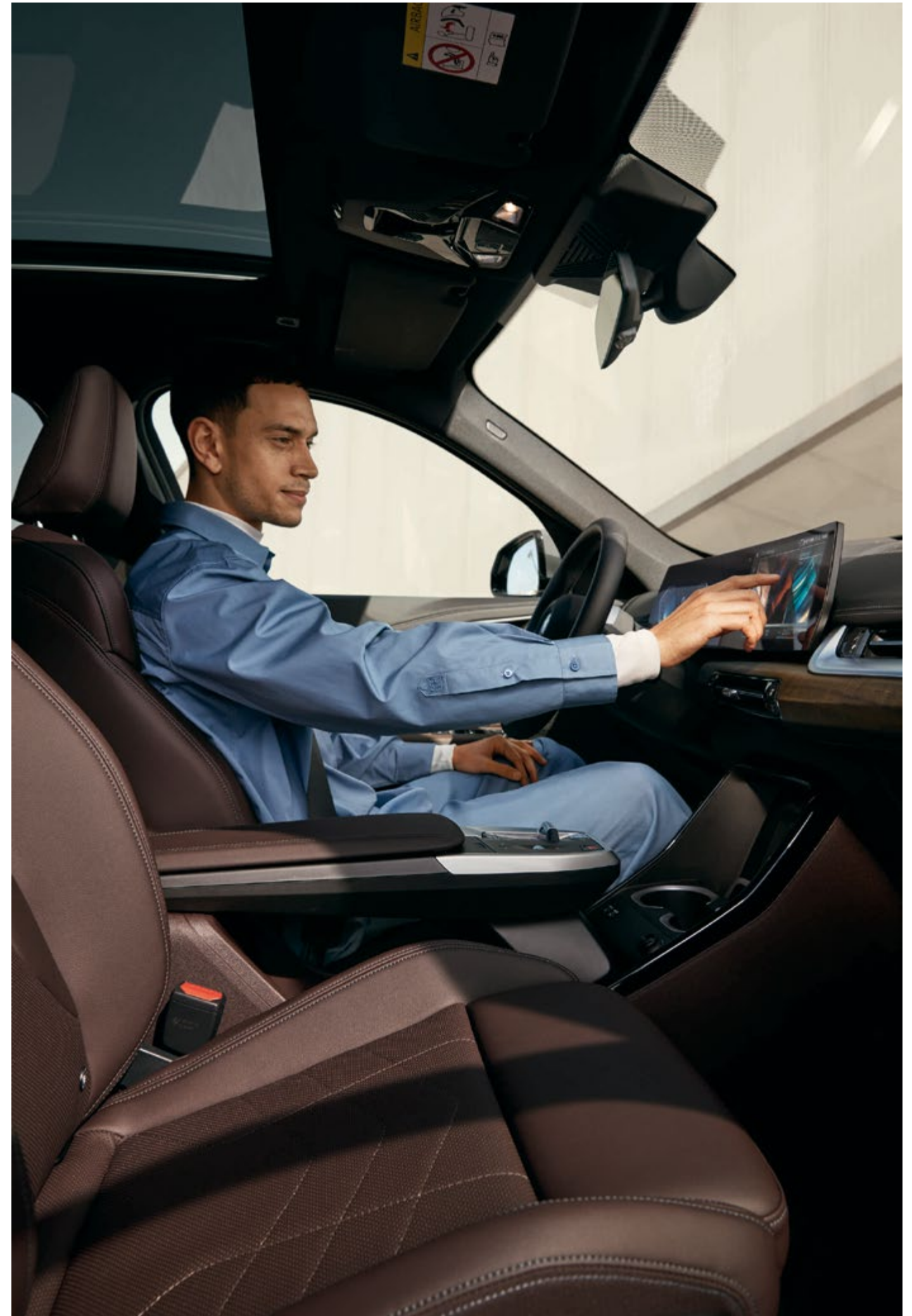



CHOSEN.  
FROM CONVICTION.

Impressive in every version: the BMW X1 impresses with powerful combustion engines, as an efficient plug-in hybrid or a fully electric BMW iX1. No matter which variant you choose: the striking Sports Activity Vehicle stands out with a consistent forward thrust and an unparalleled driving experience.



# UNBRIDLED DRIVING PLEASURE.



Irresistibly sporty: the BMW iX1 accelerates from 0–100 km/h in 5.6 seconds and impresses with power up to 230 kW. BMW xDrive, automatic 7-speed Steptronic transmission and the lowered Adaptive M suspension provide added traction, driving dynamics and driving safety. Powerful TwinPower Turbo 2.0-litre 4-cylinder diesel engines guarantee spirited power delivery.



BMW iDrive seamlessly continues your everyday digital experience in the BMW X1: with natural interaction and always at the cutting edge. The BMW Operating System 8 enables intuitive operation of vehicle functions via voice, control display or multifunction steering wheel. MyModes allows you to create a harmonious overall experience of driving dynamics and ambience.

VITAL, DIGITAL,  
BRILLIANT.



# COMFORTABLE SAFETY.

Innovative driver assistance systems provide support in critical situations. The Driving Assistant brakes independently in an emergency and helps to prevent speeding. Parking and manoeuvring in confined spaces is almost child's play with the Parking Assistant. Active Park Distance Control brakes your BMW automatically in the event of an impending collision during reverse parking.



# A FULL CHARGE OF SPONTANEITY.

Full of energy in any situation: The first all-electric BMW iX1 and BMW X1 plug-in hybrid offer the highest level of comfort with numerous charging solutions for at home and on the go for every charging process. Whether using a flexible fast charger, intelligent Wallbox or standard charging cable (Mode 3) – these sophisticated charging accessories ensure that you can recharge your batteries quickly and easily. Individual installation services are available on request, so that your next trip is guaranteed to be just around the corner.



# BOUNDLESSLY ELECTRIFYING.

The BMW iX1 xDrive 30: with an eRange of up to 438 km and a charging capacity of 10% to 80% in approx. 29 minutes.<sup>1,\*</sup>



<sup>1</sup> Provisional technical data.

\* At a high-power charging station, e.g. IONITY.

# FOUR CYLINDERS, ONE GOAL: FORWARDS.

The xDrive 23i.





POWER  
SQUARED.

The X1 xDrive 30e.





## MODEL VARIANTS AT A GLANCE.



### BMW ELECTRIC VEHICLE

Simply electrifying: the BMW iX1.



### BASIC VERSION



Powerfully harmonious: the BMW X1.



### M SPORT PACKAGE



A dynamic bundle of energy: the BMW X1 with M Sport package.

### BMW PLUGIN HYBRID



Flexibility, redefined: the BMW X1 as a plug-in hybrid.



### xLINE



Directly convincing: the BMW X1 with xLine.

## SELECTED STANDARD EQUIPMENT.

You will find **selected standard equipment** for your vehicle here. Discover more using the **BMW Products app**. Available for smartphones and tablets.

### INTERIOR

#### Standard steering wheel

The black sport leather steering wheel incl. multifunction features moulded thumb rests for a particularly pleasant and high-grip feel.

#### Widescreen Display

The BMW Curved Display combines intuitive operation with a display cluster consisting of a 10.25" instrument display and a 10.7" control display.

#### My Modes

Whether sporty, efficient or individual – My Modes can be used to create a harmonious overall experience by adjusting the driving dynamics and interior settings.

### CONNECTIVITY AND INFOTAINMENT

#### BMW Live Cockpit Plus

The BMW Live Cockpit Plus comprises a curved display combination consisting of a 10.25" instrument display and a 10.7" touch control display.

#### BMW iDrive

BMW iDrive seamlessly continues your everyday digital experience, in an advanced vehicle interior, with natural interaction and always at the cutting edge.

### DRIVER ASSISTANCE AND SAFETY

#### Parking Assistant

Parking Assistant makes it easier for you to park and manoeuvre in tight spaces and prevents parking damage.

#### Active Guard

The driver assistance systems of the Active Guard package increase safety while driving and help to avoid exceeding the speed limit.

#### Attentiveness Assistant

The Attentiveness Assistant checks your steering behaviour for signs of fatigue and recommends that you take a break if necessary.

### COMFORT AND FUNCTIONALITY

#### Automatic air conditioning

The intelligent automatic air conditioning with 2-zone control impresses with easy operation, numerous functions and optimum climate comfort.

#### Automatic tailgate operation

Automatic tailgate operation allows the electrical opening and closing of the tailgate – simply by pressing the relevant button.

# BMW ELECTRIC VEHICLE.

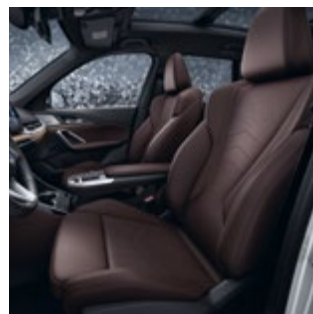

17" light alloy wheels Star-spoke style 864 Silver Grey, wheel size 7.5 J x 17 with 205/65 R17 tyres.

Interior trim finishers fine-wood trim eucalyptus open-pored with Pearl Chrome finisher on instrument panel and front doors and additional accent trim strip on centre console

Sensatec KHYM perforated Mocha, interior colour Black, extended equipment colour Mocha

## SELECTED BMW ELECTRIC VEHICLE EXTERIOR EQUIPMENT RANGES:

- LED headlights and LED rear lights
- Light alloy wheels
- Automatic tailgate operation

## SELECTED BMW ELECTRIC VEHICLE INTERIOR EQUIPMENT RANGES:

- BMW Live Cockpit Plus with BMW Curved Display
- BMW Operating System 8 with navigation
- Automatic air conditioning with 2-zone control incl. rear vent
- Sport leather steering wheel
- Through-loading system 40:20:40 with backrest tilt adjustment
- Light package
- Parking Assistant incl. Active Park Distance Control and Reversing Assist Camera
- Cruise Control with brake function

The availability of some equipment features, functions and digital services depends on engine versions or additional optional equipment. The offer structure as well as market and production availability may vary.

For detailed information about availabilities, duration and costs, contact your local BMW authorised workshop.

# BASE.

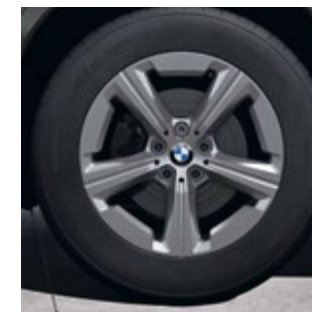
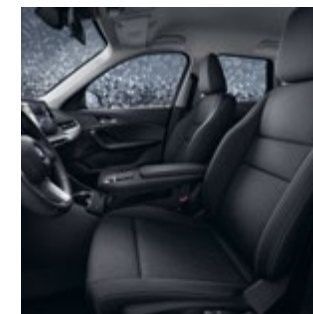

17" light alloy wheels Star-spoke style 832 Light Grey, wheel size 7J x 17 with 205/65 R17 tyres.

The black sport leather steering wheel incl. multifunction features moulded thumb rests for a particularly pleasant and high-grip feel. A Pearl Chrome trim element on the steering wheel spokes adds a refined look. You can manually adjust the height and depth of the steering wheel for optimal positioning.

The standard seats for driver and front passenger offer a great deal of comfort. The seat height, fore/aft position, backrest angle and head restraint height can be adjusted manually. A map pocket is located on the rear panel. The seat belt buckle tensioner and belt force limiter also increase safety.

## SELECTED BASE MODEL EXTERIOR EQUIPMENT FEATURES:

- LED headlights and LED rear lights
- Light alloy wheels
- Automatic tailgate operation

## SELECTED BASE MODEL INTERIOR EQUIPMENT FEATURES:

- BMW Live Cockpit Plus with BMW Curved Display
- BMW Operating System 8 with navigation
- Automatic air conditioning with 2-zone control incl. rear vent
- Sport leather steering wheel
- Through-loading system 40:20:40 with backrest tilt adjustment
- Light package
- Parking Assistant incl. Active Park Distance Control and Reversing Assist Camera
- Cruise Control with brake function

The availability of some equipment features, functions and digital services depends on engine versions or additional optional equipment. The offer structure as well as market and production availability may vary.

For detailed information about availabilities, duration and costs, contact your local BMW authorised workshop.

## M SPORT PACKAGE.

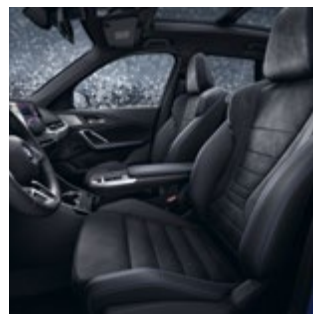

19" M light alloy wheels Double-spoke style 871 M Bicolour Black Grey, gloss-lathed, wheel size 8J x 19 with 245/45 R19 tyres.

The M leather steering wheel with contoured thumb rests and integrated shift paddles conveys a direct, sporty steering feel. The multifunction buttons in the steering wheel spokes allow you to conveniently operate various vehicle functions such as the instrument display. A visually attractive detail: the accent strip in pearlescent chrome.

Dynamic and comfortable: The individually adjustable sport seats for driver and front passenger feature numerous adjustment options, including seat depth and tilt. The raised seat and backrest bolsters as well as the pronounced shoulder support offer excellent ergonomics and more side support during brisk cornering.

### SELECTED M SPORT PACKAGE EXTERIOR EQUIPMENT RANGES:

- Kidney frame in Chrome with front sides of the kidney bars in satin aluminium
- Side sill trims with wheel arch trims in a distinctive design in the vehicle colour
- Front and rear bumper panels with distinctive design in the vehicle colour and Black high-gloss inserts<sup>1</sup>
- 18" M light alloy wheels, Double-spoke style 838 M Bicolour; other wheels available
- Adaptive M suspension
- Roof mouldings in the vehicle colour
- M High-gloss Shadowline exterior trim
- M designation on the sides
- Alpine White paintwork; other paintwork available

### SELECTED M SPORT PACKAGE INTERIOR EQUIPMENT RANGES:

- M front entry sills and M pedals
- Sport seats for driver and front passenger in Alcantara/Sensatec combination, Black with Blue contrast stitching; other upholstery available
- M leather steering wheel with shift paddles
- Luxury instrument panel
- Car key with exclusive M identification
- M anthracite headliner
- Aluminium Hexacube Dark M interior trim; other trims available

<sup>1</sup> In conjunction with the M High-gloss Shadowline exterior trim or with the M High-gloss Shadowline exterior trim with extended elements, the cover trims on the front and rear bumper panels are finished in Black high-gloss.

The availability of some equipment features, functions and digital services depends on engine versions or additional optional equipment. The offer structure as well as market and production availability may vary.

For detailed information about availabilities, duration and costs, contact your local BMW authorised workshop.

## BMW PLUG-IN HYBRID.

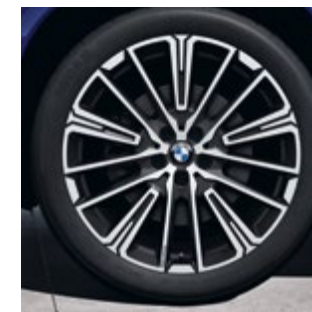
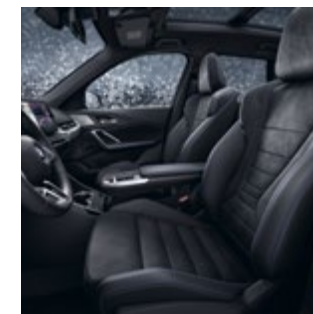

20" BMW Individual light alloy wheels Multi-spoke style 869 I Bicolour Black Grey matt, gloss-lathed, wheel size 8J x 20 with 245/40 R20 tyres.

Aluminium Hexacube Dark interior trim finishers with Pearl Chrome finisher on instrument panel and front doors and additional accent trim strip on centre console

Alcantara/Sensatec combination KGNL Black, accent Blue, interior colour Black

### SELECTED BMW PLUG-IN HYBRID EXTERIOR EQUIPMENT FEATURES:

- LED headlights and LED rear lights
- Light alloy wheels
- Automatic tailgate operation

### SELECTED BMW PLUG-IN HYBRID INTERIOR EQUIPMENT FEATURES:

- BMW Live Cockpit Plus with BMW Curved Display
- BMW Operating System 8 with navigation
- Automatic air conditioning with 2-zone control incl. rear vent
- Sport leather steering wheel
- Through-loading system 40:20:40 with backrest tilt adjustment
- Light package
- Parking Assistant incl. Active Park Distance Control and Reversing Assist Camera
- Cruise Control with brake function

The availability of some equipment features, functions and digital services depends on engine versions or additional optional equipment. The offer structure as well as market and production availability may vary.

For detailed information about availabilities, duration and costs, contact your local BMW authorised workshop.

## BMW xLINE.

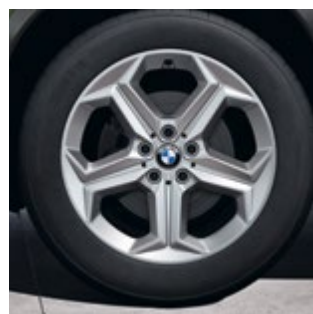

Interior trim finishers fine-wood trim eucalyptus open-pored with Pearl Chrome finisher on instrument panel and front doors and additional accent trim strip on centre console

18" light alloy wheels Star-spoke style 865 Silver Grey, wheel size 7.5J x 18 with 225/55 R18 tyres.

### SELECTED xLINE EXTERIOR EQUIPMENT:

- Kidney frame in Pearl Chrome
- Kidney slats in Black high-gloss, front in Pearl Chrome
- Surrounding trim parts at bottom in contrasting Dark Grey
- Mirror folding in silky matt chrome
- Trim parts in the front and rear apron in Pearl Chrome
- Roof mouldings in body colour
- Entry sills with BMW designation in matt aluminium
- M designation on the sides
- Alpine White paintwork; other paintwork available

### SELECTED xLINE INTERIOR EQUIPMENT:

- Perforated Sensatec seat covers and armrests with contrast stitching
- Luxury instrument panel
- Illuminated trim strips in Black high-gloss
- Pearl Chrome touches on the door handles

The availability of some equipment features, functions and digital services depends on engine versions or additional optional equipment. The offer structure as well as market and production availability may vary.

For detailed information about availabilities, duration and costs, contact your local BMW authorised workshop.

## SELECTED EQUIPMENT PACKAGES.



### TRAVEL PACKAGE.

The Travel package makes travelling in your BMW X1 even more comfortable. The rear seat adjustment allows even more flexible use of the rear and the luggage compartment, while the luggage compartment partition net ensures that your items are stowed away securely. The sun protection glazing for the rear window and the tinted side windows at the rear reduce the degree to which the vehicle interior heats up and thus contribute to a pleasant interior climate. When open, the panoramic glass sunroof ensures plenty of fresh air and also creates a friendly, light-filled atmosphere when closed.

### COMFORT PACKAGE.

Reach your destination relaxed and in a good mood: with the Comfort package, you can experience the joy of driving deluxe. The oscillating seat base function for the driver provides optimum seating comfort with an electrically adjustable lumbar support including an integrated massage function. Thanks to the electric seat adjustment with memory function for seat and exterior mirror adjustment, you can easily find your ideal position at any time. With the loudspeaker system – harman/kardon, you can also enjoy a brilliant sound experience in your BMW X1 – including a classy look.



## EQUIPMENT HIGHLIGHTS.

Discover select standard and optional equipment highlights. Some of the optional equipment shown is not included in the basic price.



The automatic 7-speed Steptronic transmission with double clutch combines high efficiency with particularly smooth gearshifts and outstanding driving comfort, thanks to tightly spaced gear ratios and fast engine speed transitions. You benefit from impressive driving dynamics with low fuel consumption at the same time. A coasting function also increases efficiency.



The automatic 7-speed Steptronic transmission with gearshift paddles combines sporty gear change with high efficiency and top driving comfort. Additional shift paddles on the steering wheel allow you to change gears in a particularly direct way without having to take your hands off the steering wheel, ensuring optimal ease of use and high safety.

The adaptive M suspension, which has been lowered by 15 mm, automatically adapts to the road conditions and driving style. You benefit from pronounced driving dynamics and excellent roadholding, while enjoying a high level of driving comfort and improved long-distance capability. The exclusive M sport steering gives a more direct steering sensation.



The availability of some equipment features, functions and digital services depends on engine versions or additional optional equipment. The offer structure as well as market and production availability may vary.

For detailed information about availabilities, duration and costs, contact your local BMW authorised workshop.

## EQUIPMENT HIGHLIGHTS.

Discover select standard and optional equipment highlights. Some of the optional equipment shown is not included in the basic price.

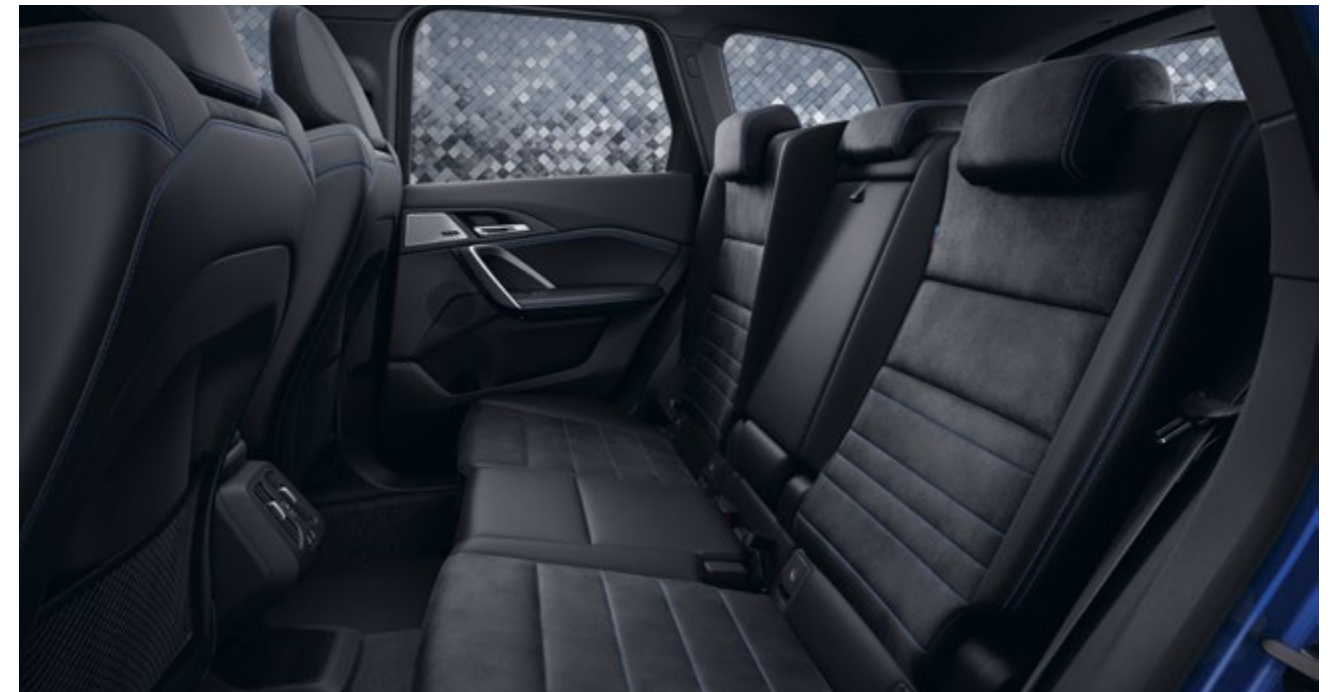

Thanks to the seat adjustment for the rear seats, the rear and luggage compartment can be used even more flexibly. The seat cushion surfaces can be shifted separately in length by 130 millimetres in a ratio of 60:40.



Save yourself the hassle of having to hold the vehicle key: with Comfort Access<sup>1</sup>, your BMW unlocks the doors automatically as soon as you approach.



The trailer coupling<sup>2</sup> with electrically adjustable ball head. Trailer Stability Control and anti-theft security mounting increase safety.

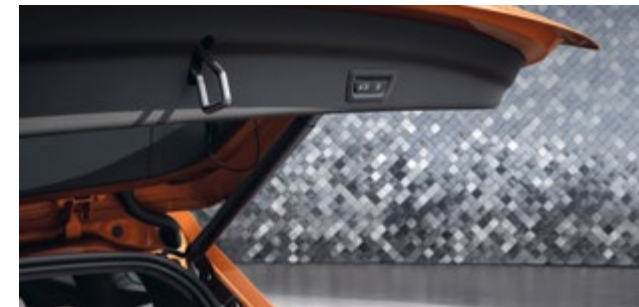

Automatic tailgate operation allows the electrical opening and closing of the tailgate – simply by pressing the relevant button.



The luggage compartment partition net behind the rear or front seats prevents objects from falling forward into the passenger area.

<sup>1</sup> BMW Digital Key Plus is compatible with selected smartphones only. A list of compatible smartphones is available at [bmw.com/digitalkey](https://www.bmw.com/digitalkey). The use of BMW Digital Key requires the Teleservices equipment.

<sup>2</sup> Please see the information on trailer load and trailer nose weight.

The availability of some equipment features, functions and digital services depends on engine versions or additional optional equipment. The offer structure as well as market and production availability may vary.

For detailed information about availabilities, duration and costs, contact your local BMW authorised workshop.

## EQUIPMENT HIGHLIGHTS.

Discover select standard and optional equipment highlights. Some of the optional equipment shown is not included in the basic price.



The equipment package Professional<sup>1</sup> offers you supplementary functions in addition to the contents of the equipment package. The BMW Live Cockpit Professional helps with navigation via Augmented View and increases comfort with the BMW Head-up Display. Parking Assistant Plus includes parking view, Remote 3D View and BMW Drive Recorder.



The equipment package<sup>1</sup> sets visual highlights and increases both comfort and safety. It includes Adaptive LED Headlights, Comfort Access, interior and exterior mirror package instrument panel, wireless charging tray, heated steering wheel preparation, driver/front passenger seat heating preparation and Driving Assistant Plus preparation.

<sup>1</sup> The steering wheel heating preparation, driver/front passenger seat heating preparation and Driving Assistant Plus preparation are required for subsequently activating the respective optional equipment via BMW ConnectedDrive Upgrades. The equipment range can vary depending on the location.

The availability of some equipment features, functions and digital services depends on engine versions or additional optional equipment. The offer structure as well as market and production availability may vary.

For detailed information about availabilities, duration and costs, contact your local BMW authorised workshop.

## EQUIPMENT HIGHLIGHTS.

Discover select standard and optional equipment highlights. Some of the optional equipment shown is not included in the basic price.



The BMW Exterior Line Satin Aluminium creates visual highlights on the outside and gives your BMW a stylish and eye-catching appearance.



The flat roof rails in matt aluminium accentuate the roof line and are the key to a multifunctional BMW roof rack unit.



High-quality appearance: with the M High-gloss Shadowline exterior trim, numerous exterior design elements of your BMW are presented in Black high-gloss.



The M high-gloss Shadow Line with extended elements gives your BMW an individual, subtly sporty look.



The exclusive M roof rails high-gloss Shadow Line form the basis for roof rack unit in order to be able to e.g., transport a roof box or bicycles.

The availability of some equipment features, functions and digital services depends on engine versions or additional optional equipment. The offer structure as well as market and production availability may vary.

For detailed information about availabilities, duration and costs, contact your local BMW authorised workshop.

## EQUIPMENT HIGHLIGHTS.

Discover select standard and optional equipment highlights. Some of the optional equipment shown is not included in the basic price.



The mirror caps are painted in Black high-gloss instead of the vehicle colour. They emphasise the vehicle's athletic look and create an individual appearance.



Thanks to the M Sport exterior parts, your BMW looks decidedly dynamic on the outside. The sporty look is ensured, among other things, by the bumper and side trim panels in a distinctive design. Further details such as the Satin Aluminium kidney grille slats or the key with M designation round off the high-quality package.



The xLine gives your BMW a striking appearance. On the exterior, dark trim elements on the lower edges of the body form an exciting contrast to the chrome sections further up. In the interior, perforated Sensatec surfaces, the Luxury instrument panel and Black high-gloss trim strips add high-quality touches.



Depending on the motorisation, the specific additional items in the M Sport package significantly increase driving dynamics, with features including faster, perceptible gear changes.

The availability of some equipment features, functions and digital services depends on engine versions or additional optional equipment. The offer structure as well as market and production availability may vary.

For detailed information about availabilities, duration and costs, contact your local BMW authorised workshop.

## EQUIPMENT HIGHLIGHTS.

Discover select standard and optional equipment highlights. Some of the optional equipment shown is not included in the basic price.



The Adaptive LED Headlights with matrix technology adapt automatically to the conditions – be it on the motorway or on country roads. Even in bad weather, you benefit from better visibility. For maximum range of vision: the headlight detects oncoming traffic as well as vehicles in front and automatically fades them out of the high-beam headlight.

The interior rear-view mirror with automatic anti-dazzle function reduces unpleasant glare caused by the headlights of vehicles behind. In return, it automatically darkens the reflective surface from a certain incidence of light. On top of that, the interior mirror is also frameless.



The M Sport interior items are synonymous with individuality in the vehicle interior. Pedal covers in a stainless steel look enhance the footwell, while an M-specific graphic lends the instrument display a sporty touch.

The availability of some equipment features, functions and digital services depends on engine versions or additional optional equipment. The offer structure as well as market and production availability may vary.

For detailed information about availabilities, duration and costs, contact your local BMW authorised workshop.

## EQUIPMENT HIGHLIGHTS.

Discover select standard and optional equipment highlights. Some of the optional equipment shown is not included in the basic price.



The M leather steering wheel with contoured thumb rests and integrated shift paddles conveys a direct, sporty steering feel. The multifunction buttons in the steering wheel spokes allow you to conveniently operate various vehicle functions such as the instrument display. A visually attractive detail: the accent strip in pearlescent chrome.



The Luxury instrument panel in Black, including the front entry sills, features a finely textured surface. The grey contrast stitching adds a visual accent. In conjunction with the Alcantara/Sensatec combination, the stitching is in blue.



When the vehicle is fitted with the M anthracite headliner, the upper A-pillar trim panels also feature Anthracite cloth in addition to the headliner. This equipment is complemented by numerous features in black: upper trim panel of the B- and C-pillars, sun visors, roof grab handles and microphone trims.

The availability of some equipment features, functions and digital services depends on engine versions or additional optional equipment. The offer structure as well as market and production availability may vary.

For detailed information about availabilities, duration and costs, contact your local BMW authorised workshop.

## EQUIPMENT HIGHLIGHTS.

Discover select standard and optional equipment highlights. Some of the optional equipment shown is not included in the basic price.



Dynamic and comfortable: The individually adjustable sport seats for driver and front passenger feature numerous adjustment options, including seat depth and tilt. The raised seat and backrest bolsters as well as the pronounced shoulder support offer excellent ergonomics and more side support during brisk cornering.



The oscillating seat base function features a lumbar support in the backrest ensuring an orthopaedically perfect sitting posture and thus optimum seating comfort. The lumbar support can be electrically adjusted in height and depth. A massage function mobilises the lower spine – you benefit from fatigue-free sitting.



With the electric seat adjustments, the two front seats can be adjusted particularly easily. The seat height, seat angle, seat longitudinal direction and backrest angle can be adjusted. The memory function allows you to save the settings for the driver's seat and exterior mirrors.

The availability of some equipment features, functions and digital services depends on engine versions or additional optional equipment. The offer structure as well as market and production availability may vary.

For detailed information about availabilities, duration and costs, contact your local BMW authorised workshop.



# EQUIPMENT HIGHLIGHTS.

Discover select standard and optional equipment highlights. Some of the optional equipment shown is not included in the basic price.



When open, the panoramic glass sunroof provides plenty of fresh air. When closed, it creates a welcoming, brightly lit atmosphere in the interior.



The Sun protection glazing for the rear window and tinted rear side windows reduces unwanted warming of the interior.



The steering wheel heating<sup>1</sup> very quickly warms up the steering wheel rim at the push of a button – a feature that's particularly useful in winter.



For noticeably more comfort on cold days, seat heating for the driver and front passenger heats the seat and backrest areas in three stages.

<sup>1</sup> The activation of the optional equipment can be added at a later date via BMW ConnectedDrive Upgrades in conjunction with the equipment package (P7EVA) or the equipment package Professional (P7EWA). The service is due to be available in the third quarter of 2022.

The availability of some equipment features, functions and digital services depends on engine versions or additional optional equipment. The offer structure as well as market and production availability may vary.

For detailed information about availabilities, duration and costs, contact your local BMW authorised workshop.

# EQUIPMENT HIGHLIGHTS.

Discover select standard and optional equipment highlights. Some of the optional equipment shown is not included in the basic price.



With its twelve loudspeakers, the loudspeaker system – harman/kardon provides an even distribution of sound in your BMW. The 7-channel amplifier guarantees that the audio will be finely tuned for a superbly crisp sound. The stainless steel trims of the tweeters with illuminated "Harman Kardon" inscription have an exclusive look.



The digital services of the Connected Package Professional<sup>1</sup> make your journey even more comfortable. Your BMW takes you to your destination as quickly as possible using up-to-date traffic data. Integrate your smartphone apps conveniently without a cable connection.



Why go without the features of your smartphone in your BMW when you can continue operating it as usual? With smartphone integration, your BMW supports Apple CarPlay and Android Auto by means of a wireless connection between your smartphone and the vehicle. This allows you to conveniently use familiar functions and various apps in the vehicle.

<sup>1</sup> Smartphone integration is permanently available in the vehicle. Parking, Connected Music and the online functions for BMW Maps Connected Navigation and Parking each have a three year term. These can be extended at the end of the term in the BMW ConnectedDrive Store. Additional optional equipment may be required to use the optional equipment. Due to possible future technical developments (e.g. of mobile phones), the usability of the Apple CarPlay or the Google Android Auto services cannot be guaranteed in the long term. CarPlay is a trademark of Apple Inc. Android Auto is a trademark of Google LLC.

The availability of some equipment features, functions and digital services depends on engine versions or additional optional equipment. The offer structure as well as market and production availability may vary.

For detailed information about availabilities, duration and costs, contact your local BMW authorised workshop.

# EQUIPMENT HIGHLIGHTS.

Discover select standard and optional equipment highlights. Some of the optional equipment shown is not included in the basic price.



Enhanced safety and more enjoyment in one with the interior camera and anti-theft recorder. If the alarm system is triggered, the system automatically creates a photo that you can view in the My BMW App. In addition, you can record beautiful driving moments via selfie, show them on the control display and download them to your smartphone.

A real all-rounder: The Driving Assistant Professional not only maintains the desired speed and distance to the vehicle in front, but also keeps your BMW on track by steering interventions. This relieves the strain, especially on longer journeys. Other functions help you avoid collisions and exceeding the speed limit.



Enjoy more relaxed travel with Driving Assistant Plus<sup>1</sup>. Especially on longer journeys, it takes the strain off you by automatically maintaining the desired speed, lane and distance from the vehicle ahead and braking in an emergency. It also warns of speed limits or no-overtaking signs.



Whether it's an imminent frontal collision or rear-end cross-traffic – Driving Assistant warns and brakes independently if necessary. It helps to prevent accidents when changing lanes and getting out of the car. It also warns following traffic of an impending rear-end collision. The system can also reduce the risk of exceeding speed limits.



The Parking Assistant Plus assistance system has more cameras in addition to the Parking Assistant and also displays the vehicle surroundings in three dimensions. This makes it even easier to monitor the manoeuvre.

<sup>1</sup> Function may be restricted in darkness, fog or bright glare.

The availability of some equipment features, functions and digital services depends on engine versions or additional optional equipment. The offer structure as well as market and production availability may vary.

For detailed information about availabilities, duration and costs, contact your local BMW authorised workshop.

# WHEELS AND TYRES.



17" light alloy wheels Star-spoke style 832 Light Grey, wheel size 7J x 17 with 205/65 R17 tyres.

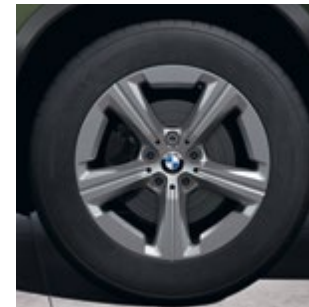

17" light alloy wheels Star-spoke style 875 Light Grey, wheel size 7J x 17 with 205/65 R17 tyres.

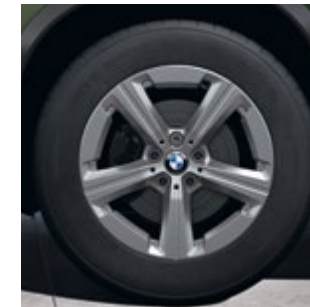

19" light alloy wheels V-spoke style 867 Bicolour Black Grey, gloss-lathed, with performance tyres, wheel size 8J x 19 with 245/45 R19 tyres.



18" aerodynamic wheels 866 Bicolour Light Grey, gloss-lathed, wheel size 7.5J x 18 with 225/55 R18 tyres.

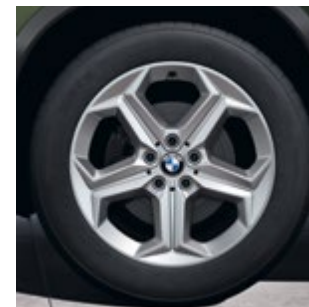

18" light alloy wheels Star-spoke style 865 Silver Grey, wheel size 7.5J x 18 with 225/55 R18 tyres.



19" M light alloy wheels Double-spoke style 871 M Bicolour Black Grey, gloss-lathed, wheel size 8J x 19 with 245/45 R19 tyres.



17" light alloy wheels Star-spoke style 864 Silver Grey, wheel size 7.5 J x 17 with 205/65 R17 tyres.



20" BMW Individual light alloy wheels Multi-spoke style 869 I Bicolour Black Grey matt, gloss-lathed, wheel size 8J x 20 with 245/40 R20 tyres.

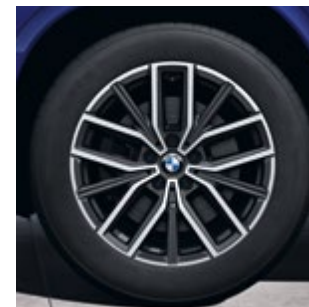

18" M light alloy wheels Double-spoke style 838 M Bicolour Dark Grey, gloss-lathed, wheel size 7.5J x 18 with 225/55 R18 tyres.

The availability of some equipment features, functions and digital services depends on engine versions or additional optional equipment. The offer structure as well as market and production availability may vary.

For detailed information about availabilities, duration and costs, contact your local BMW authorised workshop.

# EXTERIOR COLOURS.



## SOLID PAINT



Non-metallic 300 Alpine White



Non-metallic 668 Black

## METALLIC



Metallic A96 Mineral White



Metallic 475 Black Sapphire



Metallic C66 Utah Orange



Metallic C5Y Cape York Green



Metallic C1M Phytionic Blue

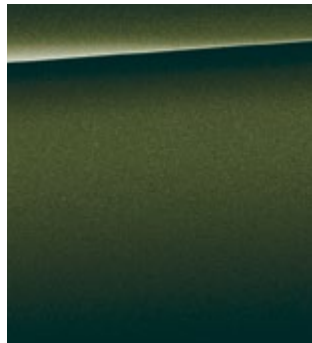

Metallic C4E Sanremo Green

## BMW INDIVIDUAL



Metallic C31 M Portimao Blue



Metallic C67 Space Silver<sup>1</sup>



BMW Individual C3N Storm Bay metallic



BMW Individual C5L Blue Bay Lagoon metallic<sup>1</sup>

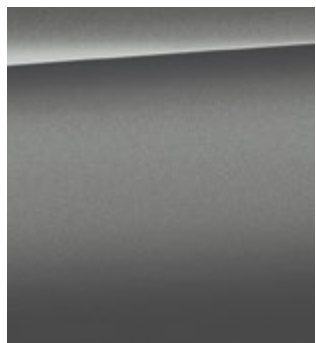

BMW Individual C5A Frozen Pure Grey metallic

**Colour samples** These colour samples are intended as an initial guide to the colours and materials available for your BMW. However, experience has shown that printed versions of paint, upholstery and interior trim colours cannot in all cases faithfully reproduce the appearance of the original colour. Please discuss your preferred colour choices with your BMW partner or in your dealership. There you can also see original samples and be assisted with special requests.

<sup>1</sup> Available from November 2022.

The availability of some equipment features, functions and digital services depends on engine versions or additional optional equipment. The offer structure as well as market and production availability may vary.

For detailed information about availabilities, duration and costs, contact your local BMW authorised workshop.

# INTERIOR COLOURS.



## UPHOLSTERY



Cloth 'Arktur' BLAT Anthracite



Sensatec KHYM perforated Mocha



Sensatec KHCX perforated Oyster

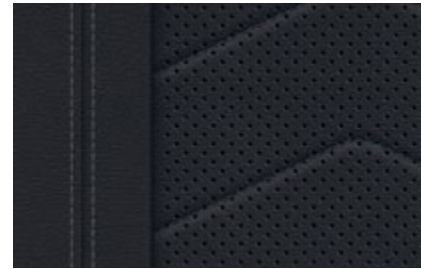

Sensatec KHSW perforated Black



Leather 'Vernasca' MACX Oyster



Leather 'Vernasca' MAMY Mocha



Leather 'Vernasca' MASW Black

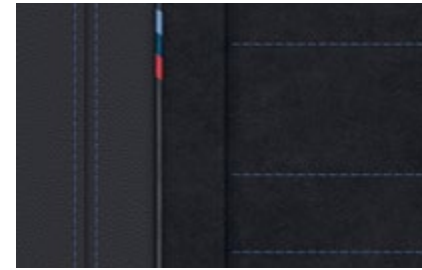

Alcantara/Sensatec combination KGNL Black, accent Blue

## INTERIOR TRIM FINISHERS

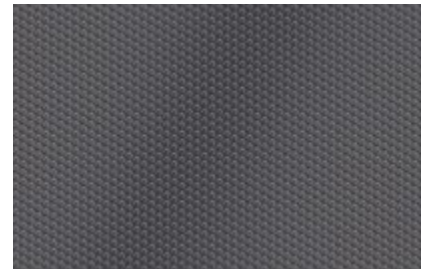

Aluminium Hexacube Dark M interior trim with Pearl Chrome finisher<sup>1</sup>



Interior trim finishers fine-wood trim eucalyptus open-pored with Pearl Chrome finisher

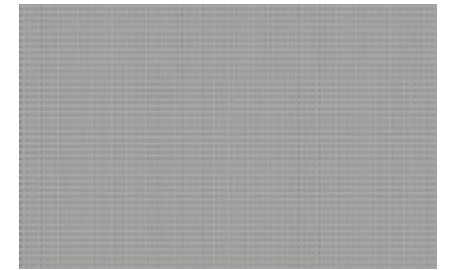

Interior trim finishers Aluminium 'Mesheffect' with highlight trim finisher in Pearl Chrome



Interior trim finishers Black high-gloss with highlight trim finisher in Pearl Chrome

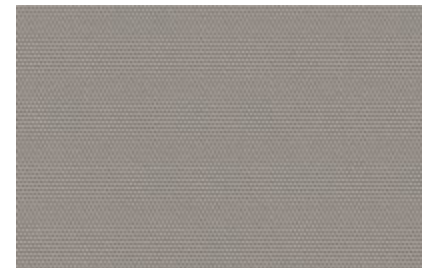

Interior trim finishers Quartz Silver matt, grained, on instrument panel

<sup>1</sup> Only in conjunction with the M Sport package.

The availability of some equipment features, functions and digital services depends on engine versions or additional optional equipment. The offer structure as well as market and production availability may vary.

For detailed information about availabilities, duration and costs, contact your local BMW authorised workshop.



## ORIGINAL BMW ACCESSORIES.

Intensive driving experiences, even further enhanced: Original BMW accessories are the best match for an original BMW. Whether you're looking for wheels and tyres, transport and luggage compartment solutions, interior equipment, communication, information and technology, charging accessories or M performance parts, with genuine BMW accessories you'll find exactly the individual solution that will allow you to discover driving pleasure as if for the first time.



### WHEELS AND TYRES.

With original BMW complete wheels, you'll reach your destination safely, and emphasise the sporty appearance of your BMW from the very first glance. But what you don't immediately realise is that they are precisely tailored to your BMW, are subject to very stringent tests with intensive material and function checks, and have been developed in close collaboration with leading tyre manufacturers – individually tuned to the driving dynamics and design language of each individual BMW model.

### TRANSPORT AND LUGGAGE COMPARTMENT SOLUTIONS.

Original BMW Accessories offer you a wide range of transport and luggage compartment solutions. In line with your personal preferences and interests, you can use them to create additional space whenever and wherever you need it. Whether carrier systems or accessories for the luggage compartment, you can always rely on original BMW accessories to be precisely tailored to your BMW, and easy to use.



### INTERIOR ACCESSORIES.

A perfect fit: all original BMW accessory products for the interior help to design the interior of your BMW to fully meet your personal preferences. In addition to the excellent functionality of original BMW accessories, you are also always choosing attractive BMW design alongside extraordinary craftsmanship and material quality – combined with an ambience that will excite you every time you drive.



### COMMUNICATION, INFORMATION AND TECHNOLOGY.

Cutting-edge functions and features for maximum freedom and flexibility: Original BMW accessories for communication, information and technology are always at your side. Whether you value optimum availability by phone or the best sound, the innovative original BMW accessories will have the right solution for you. You'll always enjoy a good connection and custom entertainment, wherever your journey takes you.

### CHARGING ACCESSORIES.

Regardless of where and how you want to charge your new BMW, original BMW charging accessories offer you tailor-made products and services. You can charge your BMW at any domestic socket using the BMW Flexible Fast Charger or, for even more convenience, at a BMW Wallbox from original BMW accessories; what's more, there's also a widespread network of public charging points available for when you're on the road. Innovative Connected Charging services show charging stations in your BMW's information display, for example, or enable you to easily start pre-conditioning your vehicle just using your smartphone.



### M PERFORMANCE PARTS.

With M performance parts, you can experience BMW's motorsport DNA with fascinating intensity, even off the racetrack. A wide range of technical and visual components makes outstanding technology a visible and tangible experience. Exclusive materials and first-rate quality guarantee flawless dynamism. Experience inspiring maximum product performance: individual, expressive and uncompromising.

The availability of the equipment shown and described may vary on a market-specific basis. Your local BMW partner will be happy to advise you on the full range of original BMW accessories.

Discover the whole range of original BMW accessories and the BMW M performance parts product portfolio.



# TECHNICAL VALUES.

		X1 sDrive18i	X1 xDrive23i <sup>6</sup>	X1 sDrive18d	X1 xDrive23d <sup>6</sup>	X1 xDrive25e <sup>7,8</sup>	X1 xDrive30e <sup>7,8</sup>	iX1 xDrive30 <sup>7,8</sup>
<b>Complete vehicle drive system<sup>2</sup></b>								
Drive type		Petrol	Petrol – 48-volt mild hybrid	Diesel	Diesel – 48-volt mild hybrid	Petrol – plug-in hybrid	Petrol – plug-in hybrid	All-electric
Power	kW (hp)	100 (136)	160 (218) <sup>11</sup>	110 (150)	155 (211) <sup>11</sup>	180 (245) <sup>11, 12</sup>	240 (326) <sup>11, 12</sup>	230 <sup>9</sup> (313 <sup>9</sup> )
Torque	Nm	230	360	360	400	477 <sup>11</sup>	477 <sup>11</sup>	494
Transmission		7-speed, automatic	7-speed, automatic	7-speed, automatic	7-speed, automatic	7-speed, automatic	7-speed, automatic	1-speed, automatic
Drive type		Front-wheel drive	All-wheel drive	Front-wheel drive	All-wheel drive	All-wheel drive	All-wheel drive	All-wheel drive
<b>BMW TwinPower Turbo engine<sup>2</sup></b>								
Cylinders		3	4	4	4	3	3	-
Capacity	cm <sup>3</sup>	1499	1998	1995	1995	1499	1499	-
Output	kW (hp)/rpm	100 (136)/4400–6500	150 (204)/5000–6500	110 (150)/3750–4000	145 (197)/4000	100 (136)/4400–6500	110 (150)/4700–6500	-
Rated torque	Nm/rpm	230/1500–4000	320/1500–4000	360/1500–2500	400/1500–2750	230/1500–4000	230/1500–4400	-
<b>Electric motor<sup>5</sup></b>								
(Nominal) output / 30 minutes output <sup>10</sup>	kW (PS)	-	14 (19)	-	14 (19)	80/ <sup>-7</sup>	130/ <sup>-7</sup>	200 (272)/ <sup>-7</sup>
(Rated) torque	Nm	-	55	-	55	247	247	<sup>-7</sup>
<b>Driving performance</b>								
Acceleration 0–100 km/h	s	9.2	7.1	8.9	7.4	6.8	5.6	5.6
Top speed	km/h	208	233	210	225	190	205	-
Top speed (electric)	km/h	-	-	-	-	140	140	180
<b>Consumption / CO<sub>2</sub> emissions<sup>2,3</sup></b>								
Fuel consumption, combined WLTP <sup>3</sup>	l/100 km	7.0–6.3	7.2–6.5	5.5–4.9	5.3–4.8	1.1–0.8	1.1–0.8	-
CO <sub>2</sub> emissions, combined WLTP	g/km	158–143	162–146	144–129	140–125	24–17	24–17	-
Consumption, electrical, combined WLTP	kWh/100 km	-	-	-	-	18.2–16.4	18.2–16.4	18.4–17.3
Electric range WLTP <sup>4</sup>	km	-	-	-	-	78–89	78–89	413–438
<b>High-voltage/48-volt battery, charging<sup>14</sup></b>								
Battery size	kWh	-	0.86	-	0.86	14.2	16.3 / 14.2	62.4
Maximum charging power AC / DC	kW	-	-	-	-	7.4 / <sup>-7</sup>	7.4 / <sup>-7</sup>	11 [22] / 130
Charging time DC 10–80%	h	-	-	-	-	-	-	00:29
Recharged range after 10 minutes of high-power charging	km	-	-	-	-	-	-	-
Charging time AC 0–100%	h	-	-	-	-	< 02:30	< 02:30	06:30 [03:45]
<b>Dimensions/weight</b>								
Length / width / height	mm	4500 / 1845 / 1642	4500 / 1845 / 1642	4500 / 1845 / 1642	4500 / 1845 / 1642	4500 / 1845 / 1630	4500 / 1845 / 1630	4500 / 1845 / 1612
Wheelbase	mm	2692	2692	2692	2692	2692	2692	2692
Unladen weight <sup>1</sup>	kg	1575	1730	1650	1765	1930	1935	2085
Luggage capacity	l	540–1600	500–1545	540–1600	500–1545	490–1495	490–1495	490–1495
Fuel tank capacity	l	45	45	45	45	47	47	-
Trailer load optionally braked ex works up to 12% / trailer load	kg	1700 / 80	2000 / 80	1800 / 80	2000 / 80	1700 / <sup>-7</sup>	1800 / <sup>-7</sup>	1200 / <sup>-7</sup>

The figures for driving performance, fuel consumption and CO<sub>2</sub> emissions refer to vehicles with standard transmission.

- The EC unladen weight refers to a vehicle with standard equipment and does not include any optional equipment. The unladen weight includes a 90% full tank and a driver weight of 75 kg. Optional equipment may affect the weight of the vehicle, the payload and the top speed if the selected equipment has an impact on the vehicle's aerodynamics.
- Performance data of petrol engines applies to vehicles using RON 98 grade fuel. Fuel consumption data applies to vehicles using reference fuels in accordance with EU Regulation 2007/715. Unleaded RON 91 fuel and higher with a maximum ethanol content of 10% (E10) may also be used. BMW recommends RON 95 unleaded premium grade fuel.
- Official data for fuel consumption, carbon dioxide emissions, power consumption and electric range was determined in accordance with the measuring procedures described and complies with European Regulation (EU) 715/2007 in the applicable version. For ranges, data determined as per WLTP takes into account any optional equipment (available on the German market in this case). For vehicles that have been newly type approved since 1 January 2021, only the official data according to WLTP exists. For more information about NEDC and WLTP measuring procedures visit [www.bmw.com/wltp](http://www.bmw.com/wltp)
- Range depends on various factors. In particular: personal driving style, route characteristics, exterior temperature, heating/air conditioning, pre-conditioning.
- At temperatures below freezing, the fully electric drive system is only available after a few kilometres of driving, once the battery has heated to operational temperature.
- This engine version is not available in all countries. For further information, please contact your local BMW authorised workshop.
- Provisional figures; any missing figures were unavailable at the time of publication.
- Expected to be available from 11/2022.
- Temporary increase <10 seconds compared to specified nominal value.
- Continuous output BEV 30 minutes.
- Comprises engine driven (specified nominal value) and electric drive (up to specified nominal value).
- Power depends on the battery charge.
- For plug-in hybrid: weighted, combined (EC AC charge weighted)
- Charging times/charging rate specified under optimal conditions (29–33 degrees Celsius battery start and ambient temperature with certification values excluding additional auxiliary consumers such as seat heating, displays, air-conditioning system)

# TECHNICAL VALUES.

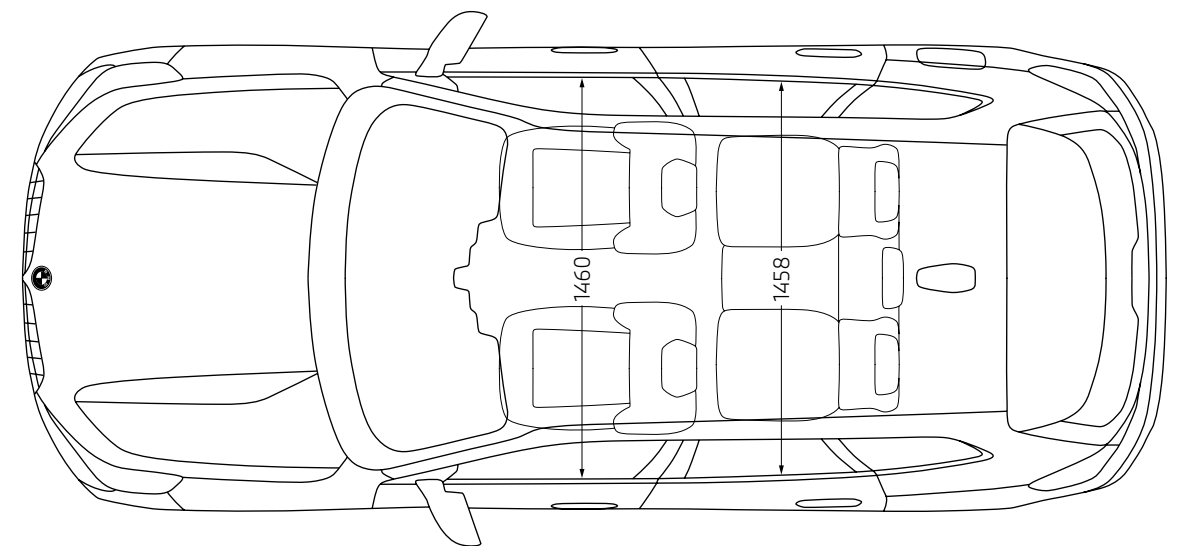
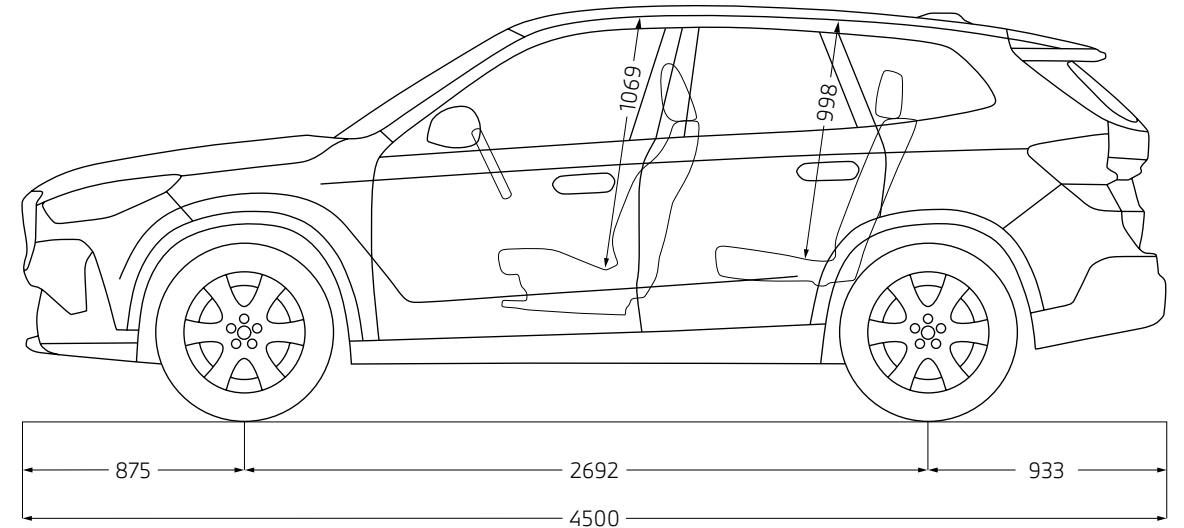
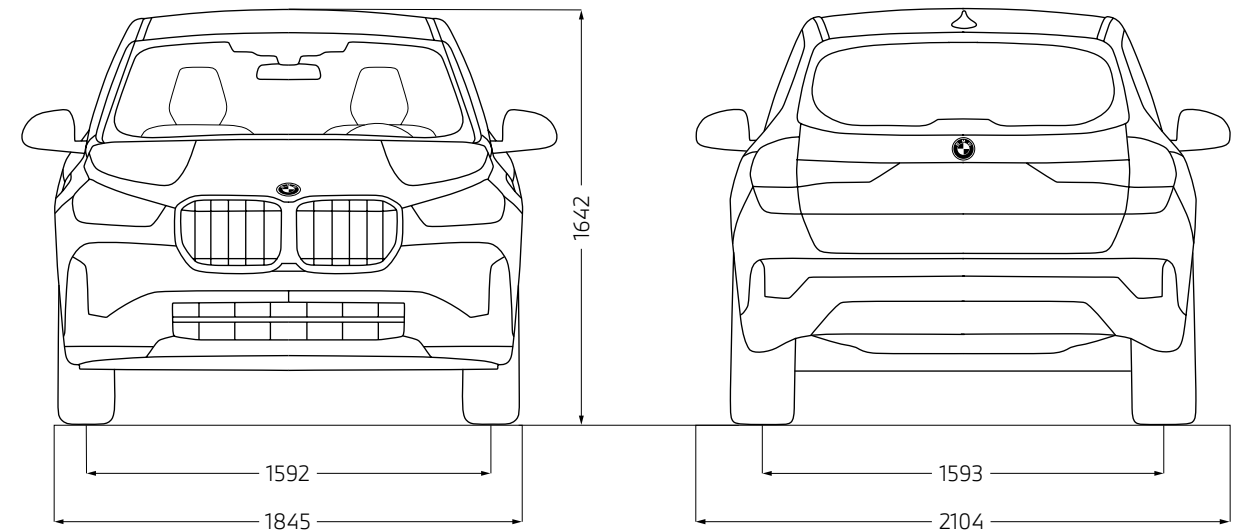

All dimensions in the technical drawing are given in millimetres.

## BMW CHARGING.



### CHARGING.

Convenient, fast and safe charging – your BMW makes this possible via the high-voltage charging socket on the side of the vehicle. The charging power socket for electric vehicles can be found on the right of the vehicle at the rear, and for plug-in hybrid electric vehicles at the front on the left.

Comfort functions make operation easier: in the dark, the search light in the charging power socket ensures that you can easily plug in the charging cable. Everything in view: the LED display of the charging power socket informs you of the current battery charge in various colours.

A temperature sensor also increases safety. It measures the temperature at the plug-in contacts and can detect potential overheating at an early stage.

The charging power socket locks and unlocks the charging plug automatically during the charging process so that it cannot be removed. If the charging plug can no longer be disconnected from the vehicle, the electrical emergency release helps in an emergency.

To keep the waiting time at AC charging stations to a minimum, you can recharge your electric vehicle there with a charging capacity of up to 11 kW. The high-voltage battery can be charged even faster at DC charging stations. Here you benefit from a charging capacity of up to 130 kW. Plug-in Hybrid Electric Vehicles, on the other hand, charge at AC charging stations with up to 7.4 kW as standard.



### CHARGING AT HOME.

Charging at home is particularly easy with the included Flexible Fast Charger. It can be used to charge your BMW X1 plug-in hybrid or your BMW iX1 from any domestic or industrial plug socket, depending on your individual charging infrastructure. A Wallbox is an even faster, more convenient way of charging. BMW offers different Wallboxes for this purpose – including an installation service on request.

## BMW CHARGING.



### PUBLIC CHARGING.

Regardless of where you are and what you are planning – you can go anywhere you want to go with your BMW electric vehicle. A fast charging cable (mode 3) for public charging is also supplied with your plug-in hybrid or all-electric BMW for hassle-free charging on the move. The BMW Charging card is also included in the scope of delivery. This gives you access to a constantly growing network of public charging stations from various operators in inner cities as well as along important European traffic transit routes. Simply use BMW Maps in your vehicle or the My BMW App on your smartphone to find nearby charging points.



### BMW CONNECTED CHARGING.

With the Connected Charging digital services, you use the range of your BMW i model efficiently while remaining flexible at all times. The system assists you in the search for public charging stations and provides important information in advance. The app also gives you an overview of relevant vehicle data.



## BMW SERVICE.



Always there for you: Your BMW Service Partner is there for helpful, expert support for everything to do with your BMW. Our aim is to make every journey in your BMW as pleasant as possible. A major worldwide network of workshops offers premium service from BMW specialists, innovative diagnostic technologies, and rapid availability of precisely fitting original BMW parts as well as original BMW engine oil. There are many great reasons to choose services from BMW, but there's one that really stands out: that driving pleasure that sets your BMW apart from the crowd will be yours to enjoy for many years to come with BMW Service.

## WHEREVER, WHENEVER: OUR COMPREHENSIVE SERVICE.

Many BMW services can be easily booked and tracked online – so you can use your time for the really important things in life. Stay independent and flexible with online appointments and remote services.

Take advantage of our innovative digital products and services such as online video advice, and get all the relevant information on your smartphone. And if you don't want to stop but have no choice, our BMW Breakdown and Accident Assistance service will help.



## SUSTAINABILITY.

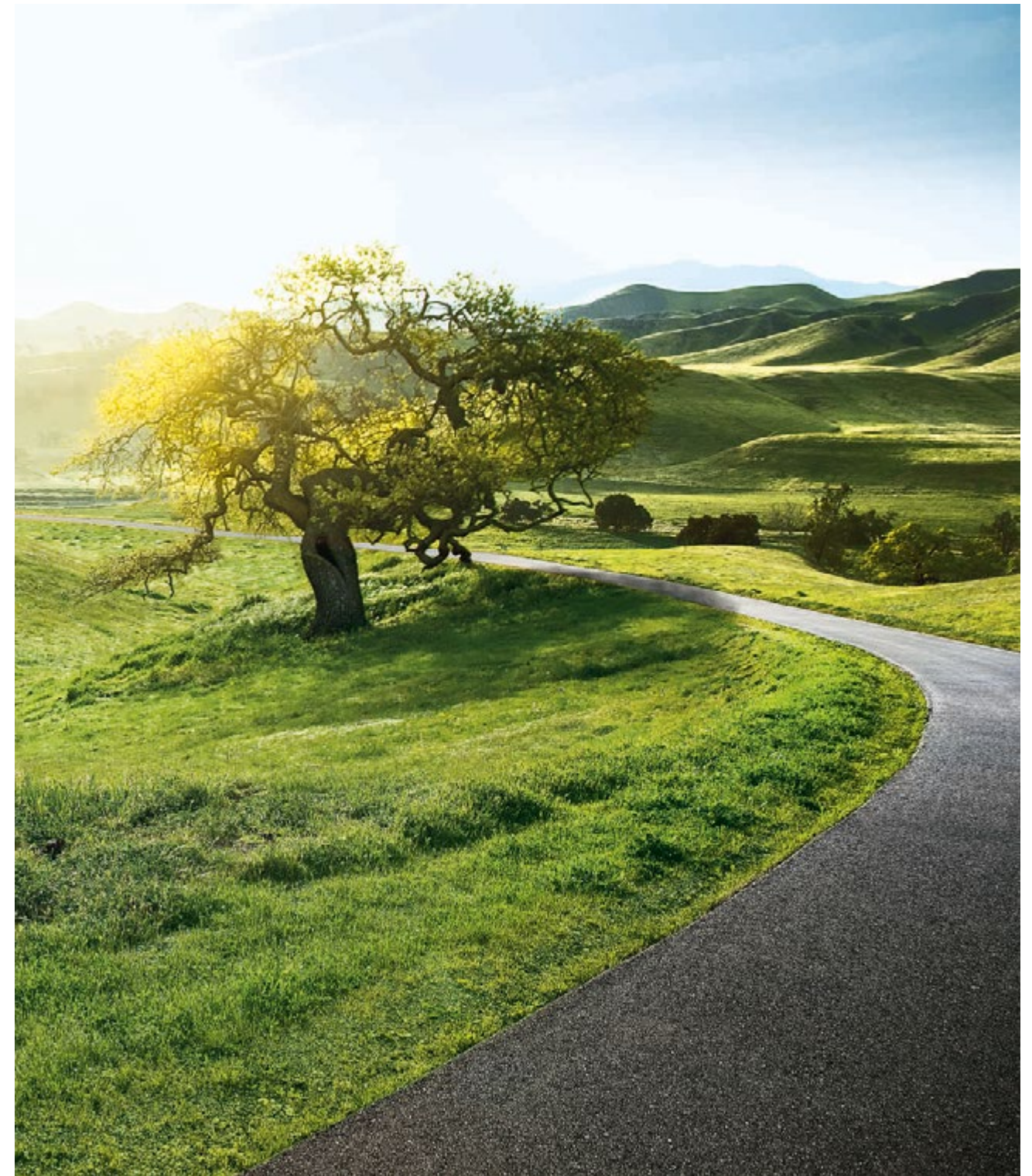

The BMW Group has been finishing at the top end of independent ratings and rankings that assess sustainability for a long time. These successes and increasing challenges in protecting the world we live in encourage us to embed sustainability as a key aspect in our corporate strategy. The development of efficient vehicle concepts, the establishment of eco-friendly production processes and the implementation of sustainable processes at our suppliers is part of our philosophy. Efficiency-enhancing technologies such as BMW EfficientDynamics and consistent electrification have enabled us to cut the CO<sub>2</sub> emissions of our

fleet of vehicles in Europe by 50% between 1995 and 2020. In addition, between 2006 and 2020 we have reduced the consumption of water by 31% and the consumption of energy in production by 38%. Our plants worldwide use green electricity only. Since 2021 our plants have even been producing completely carbon neutrally. And, of course, each of our vehicles is designed for easy or economical recycling after its long-running life. Please contact your BMW partner on all matters regarding your end-of-life vehicle. For more information on this issue please visit our website.

Of course, each vehicle is designed for economical recycling after its long-running life. You can find more information regarding your end-of-life vehicle on our website [www.bmw.de/recycling](https://www.bmw.de/recycling)

© BMW AG, Munich, Germany. Not to be reproduced wholly or in part without prior written permission of BMW AG, Munich.

411 001 246 20 2 2022 CB.